



ÜNVER®

AĞAÇ İŞLEME MAKİNALARI

SINCE 1980

KOMBİNE MAKİNASI 3 FONKSİYONU COMBINATION MACHINE WITH 3 FUNCTION

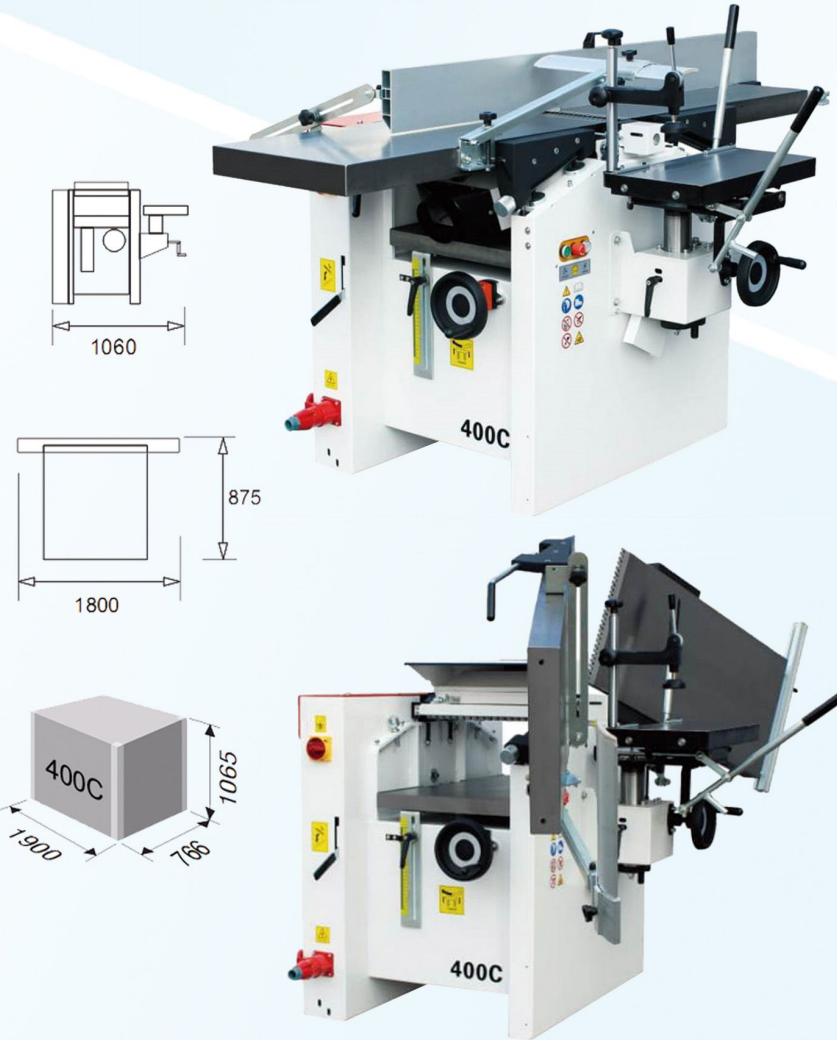

Planya	Planner	400C	300C
Tabla Ölçüsü	Working Table	400*1800 mm	300*1500 mm
Kesici Bıçak Çapı	Cutterblock Diameter	70mm	70mm
İş Mili Çapı	Cutterblock Rotation Speed	5700 rpm	5700 rpm
Kesici Bıçak Sayısı	Number of Knives	3	3
Kesici Bıçak Ölçüleri	Knife Dimensions	400*20*3 mm	300*20*3 mm
Maksimum Tabla ayar	Max Table Adjustment	4 mm	4 mm
Kalnlık	Thicknesser	400C	300C
Tabla Ölçüsü	Working Table	400*760 mm	300*660 mm
İlerleme Hızı	Feed Speed	7 m/s	7 m/s
Minimum & Maksimum Çalma Yüksekliği	Minimum & Maximum Working Height	4 - 220 mm	4 - 220 mm
İş Mili Devri	Cutterblock Rotation Speed	5700 rpm	5700 rpm
Maksimum Kesme Serinliği	Max Cutting Depth	4 mm	4 mm
Yatay Delik	Mortiser	400C	300C
Tabla Ölçüsü	Working table	250*500mm	250*500mm
Boyuna – Enine – Dikeyine Kurs Boyu	Longitudinal - Transversal – Vertical stroke	205 mm – 95 mm – 90 mm	205 mm – 95 mm – 90 mm
Mandren (M18x1.5-S)	Chuck (M18x1.5-S)	16mm	16mm
Standart Özellikler	Standard Accessories	400C	300C
3 Faz Motor Gücü	3-Phase Motor Power	4 HP (3 kw)	3 HP (2.2 kw)
Ağırlık	Weight	385 kg	290 kg

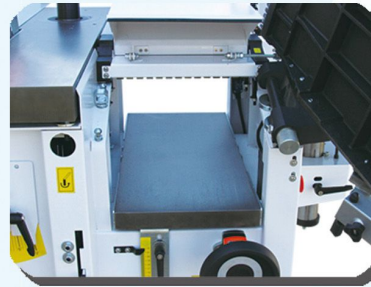

Kalnlık
Thicknesser

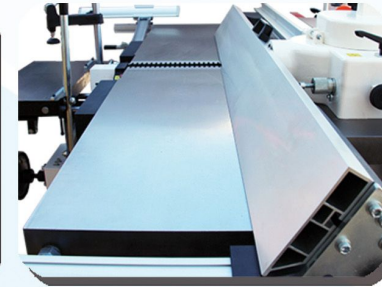

Planya
Surface Planer



Yatay Delik
Mortiser

MAĞAZA / SHOWROOM
Önder Mah. Ereğli Cad. No: 11
Siteler / Altındağ / ANKARA / TURKEY
Tel: +90 312 349 68 68 - 69
Fax: +90 312 351 80 80

FABRİKA / FACTORY
Tezcan Sokak No:17 B/C/D
Siteler / ANKARA / TURKEY
Tel: +90 312 815 15 58
Fax: +90 312 815 15 59



www.unvermakina.com.tr | unvermakina@unvermakina.com.tr
www.instagram.com/unver_makina | www.facebook.com/unvermakina



ÜNER®

AĞAÇ İŞLEME MAKİNALARI

SINCE 1980

OPSİYONEL ÖZELLİKLER

OPTIONAL FEATURES



OPSİYONEL HELİSEL BİÇAK
OPTIONAL HELICAL CUTTER



OPSİYONEL & KALINLIK BİÇAKLARI
OPTIONAL PLANER & THICKNESSER CUTTERS



OPSİYONEL KESİCİ VE ÇİZİCİ TESTERELER
OPTIONAL SAW AND SCORER BLADES



OPSİYONEL SOL MATKAPLAR
OPTIONAL LEFT DRILLS



OPSİYONEL MANDERN
OPTIONAL WESCOTT

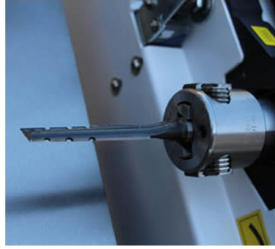

OPSİYONEL TARAMA BİÇAKLARI SETİ (6 ADET)
OPTIONAL MORTISER BITS (NO:6)



Dia. (mm)	Length (mm)
Φ6	105
Φ8	115
Φ10	125
Φ12	135
Φ14	145
Φ16	155

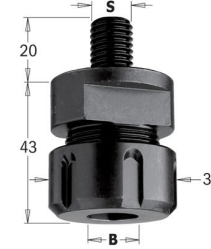

ER20 PENS MANDRENİ M14
ER20 CHUCK M14



ER20 PENS
ER20 PLIERS



ER20 MANDREN ANAHTARI
ER20 WESCOTT WRENCH

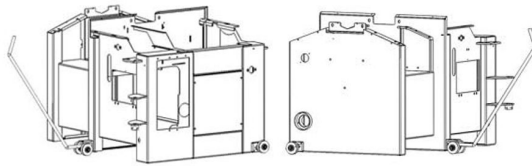

OPSİYONEL TAŞIMA TEKERLERİ
OPTIONAL MOVING WHEELS



PROFİL TOPU BİÇAKLARI
PROFILE CUTTER HEADS

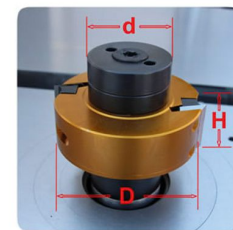

OPSİYONEL KAYIŞLAR
OPTIONAL BELTS

MAĞAZA / SHOWROOM
Önder Mah. Akçeşme Sok. No: 14
Siteler / Altındağ / ANKARA / TURKEY
Tel: +90 312 349 68 68 - 69
Fax: +90 312 351 80 80

FABRİKA / FACTORY
Önder Mah. Akçakale 2 Cadde No: 95
Siteler / ANKARA / TURKEY
Tel: +90 312 815 15 58
Fax: +90 312 815 15 59



www.unvermakina.com.tr | unvermakina@unvermakina.com.tr
www.instagram.com/unver_makina | www.facebook.com/unvermakina